

advanced FLOW engineering

Instruction Manual P/N: 46-71080A / 46-71080B

Make: **GM** Model: **2500HD/3500HD** Year: **2011-2016** Engine: **V8-6.6L**



- Please read the entire instruction manual before proceeding.
- Ensure all components listed are present.
- If you are missing any of the components, call customer support at 951-493-7100.
- Ensure you have all necessary tools before proceeding.
- Do not attempt to work on your vehicle when the engine is hot.
- Disconnect the negative battery terminal before proceeding.
- Retain factory parts for future use.

Label	Qty.	Description	Part Number
A1	1	Oil Pan – Raw, Machined Fins (46-71080A)	05-60972A
A2	1	Oil Pan – Black, Machined Fins (46-71080B)	05-60972B
B	1	Sensor Bracket	05-61016
C	1	RTV Silicone	05-60096
D	18	Screw, Socket Head M6x1.0x20	03-50241
E	2	Screw, Button Head M6x1.0x12	03-50102
F	20	Washer, M6	03-50177
G	1	Washer, M10	03-50470
H	1	Crush Washer	03-50384
I	2	Nut, M6	03-50059
J	1	Drain Plug, Magnetic M12x1.25	03-50385
K	1	Plug, 1/2" NPT	03-50249
L	1	Oil Filter	44-LF001

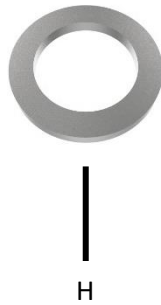
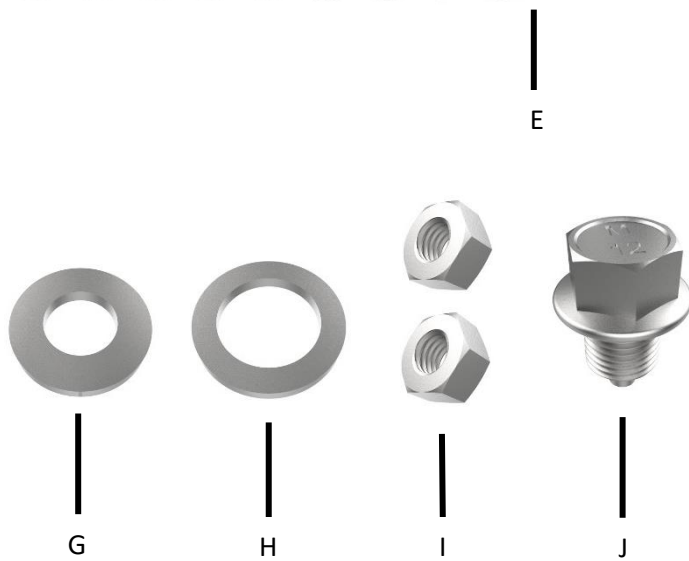
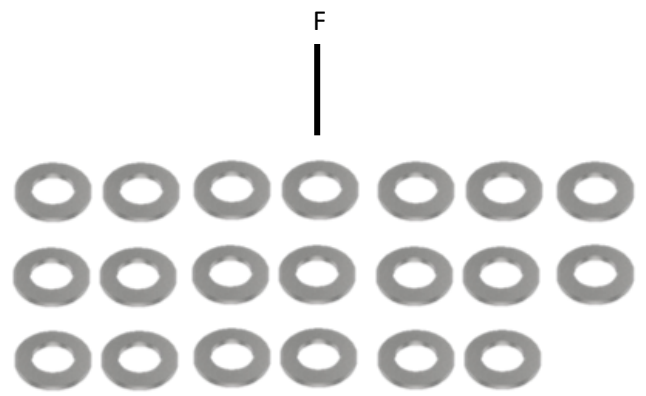
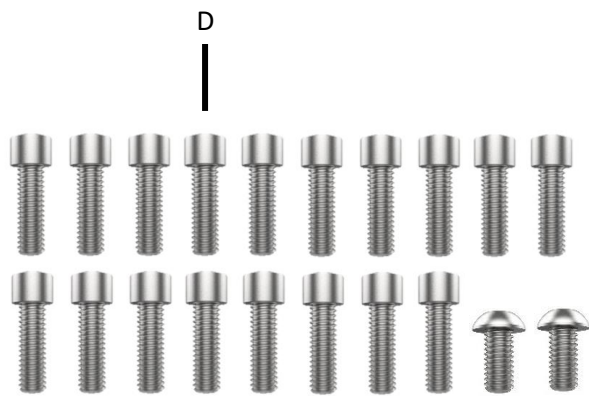



1. Park your vehicle on a flat, dry surface. You will need to block the tires to prevent the vehicle from rolling.

Note: You will need to get under the truck to do this installation. Please use every precaution when lifting the vehicle.

2. Remove the crossmember from the vehicle to gain access to the OEM pan.
3. Place a drain pan under the oil pan. Remove the drain plug and allow the oil to drain.
4. Reinstall the drain plug.



5. Disconnect the sensor connector and make sure that all wires are out of the way.

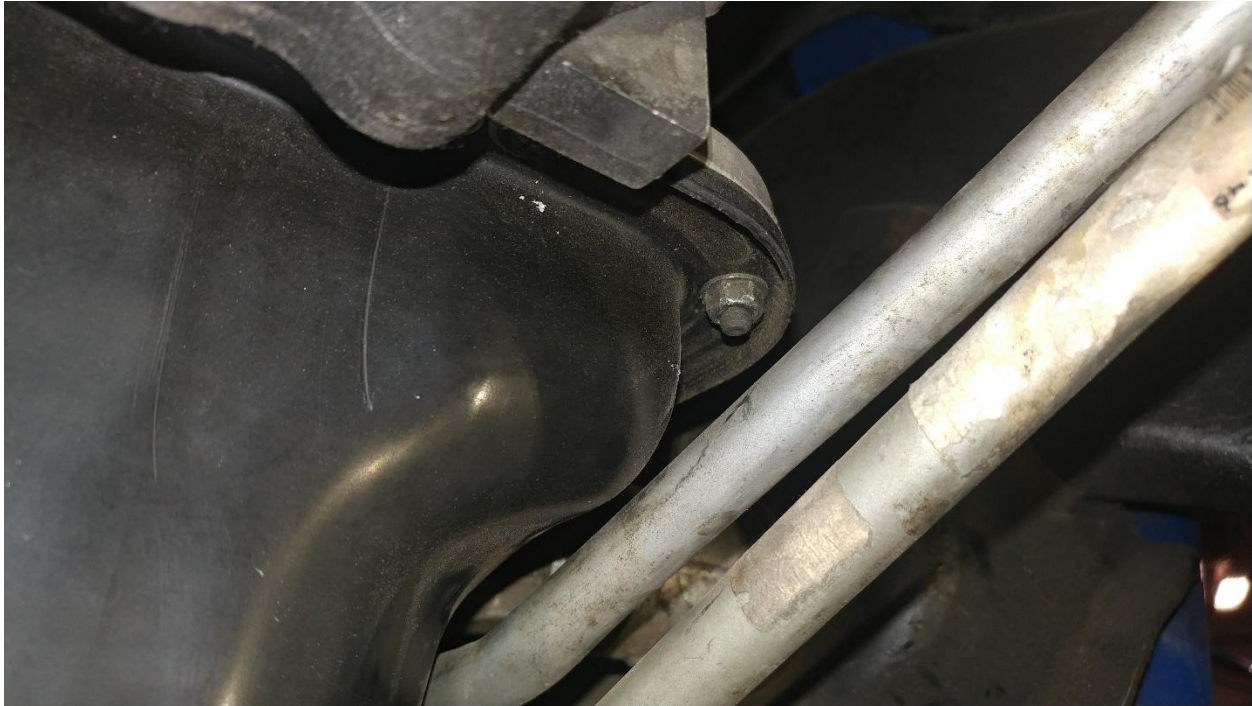

6. Remove the 16 screws from the oil pan.
7. Remove the two (2) remaining nuts from the oil pan.
8. Carefully insert a gasket scraper between the engine block and the oil pan. Pry the oil pan off. **Do not gouge the oil pan sealing surface.**

Note: There will still be about 1/2 quart of oil in the bottom of the oil pan. Be careful not to spill this remaining oil.



9. Remove the two (2) remaining studs by interlocking the two (2) supplied M6 nuts on each stud and unscrewing it from the gasket surface.
10. Clean the oil pan sealing surface with a gasket scraper. Be careful not to gouge the surface while cleaning.

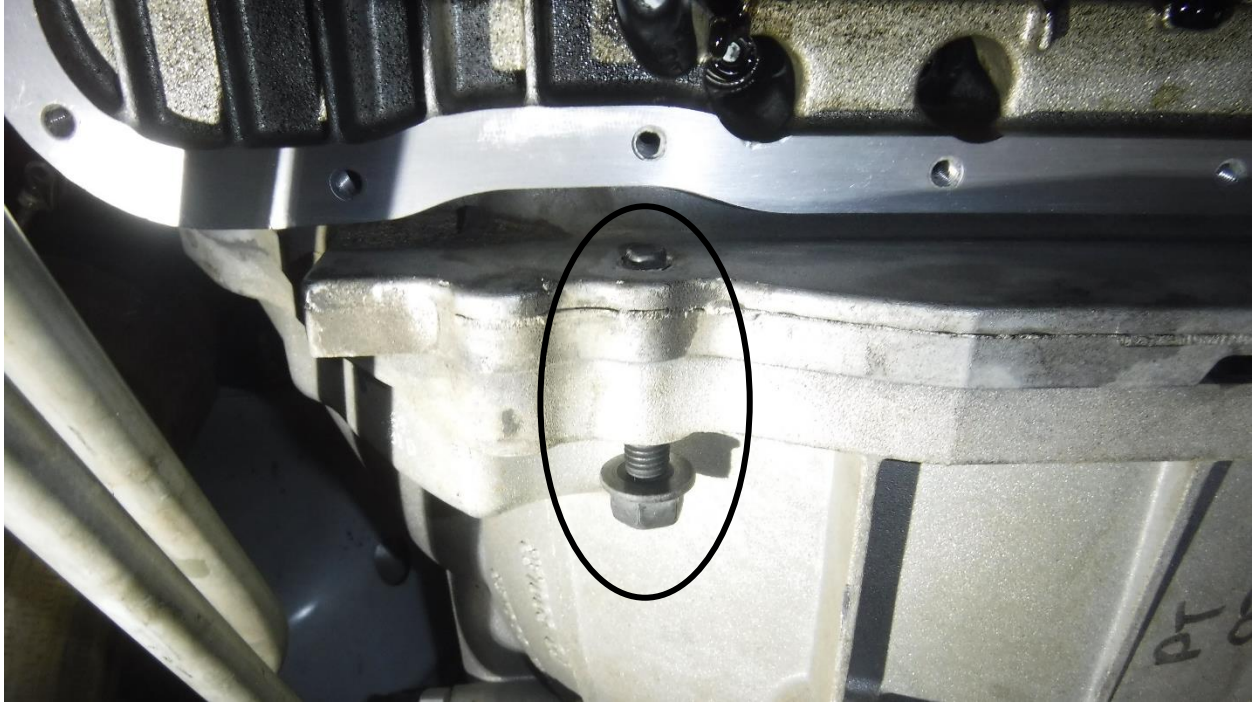

11. Completely remove the transmission bolt from the passenger side of the vehicle as shown above.
12. Make sure that everything is clear and out of the way of installing the aFe oil pan.

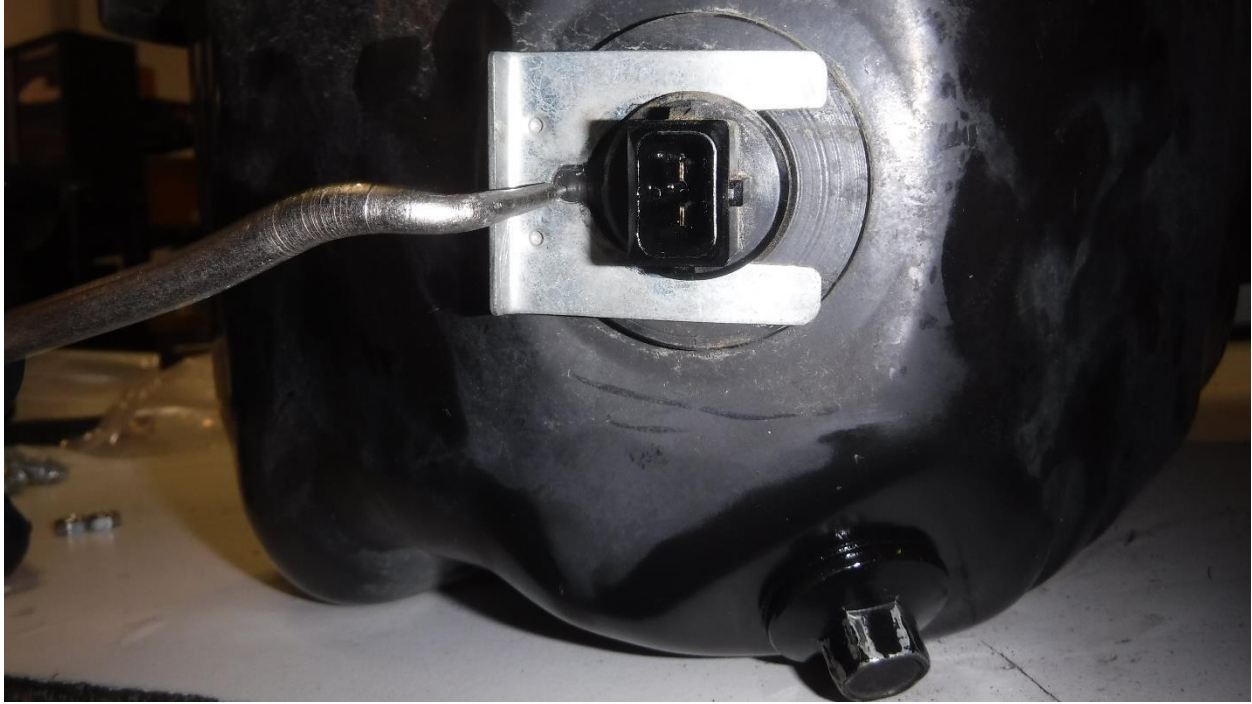

13. Pry the metal holding clip from the outside of the oil pan.



14. Once this holding clip is removed, push the connector towards the inside of the pan.



15. Remove the two (2) screws holding the sensor to the bracket inside the oil pan.

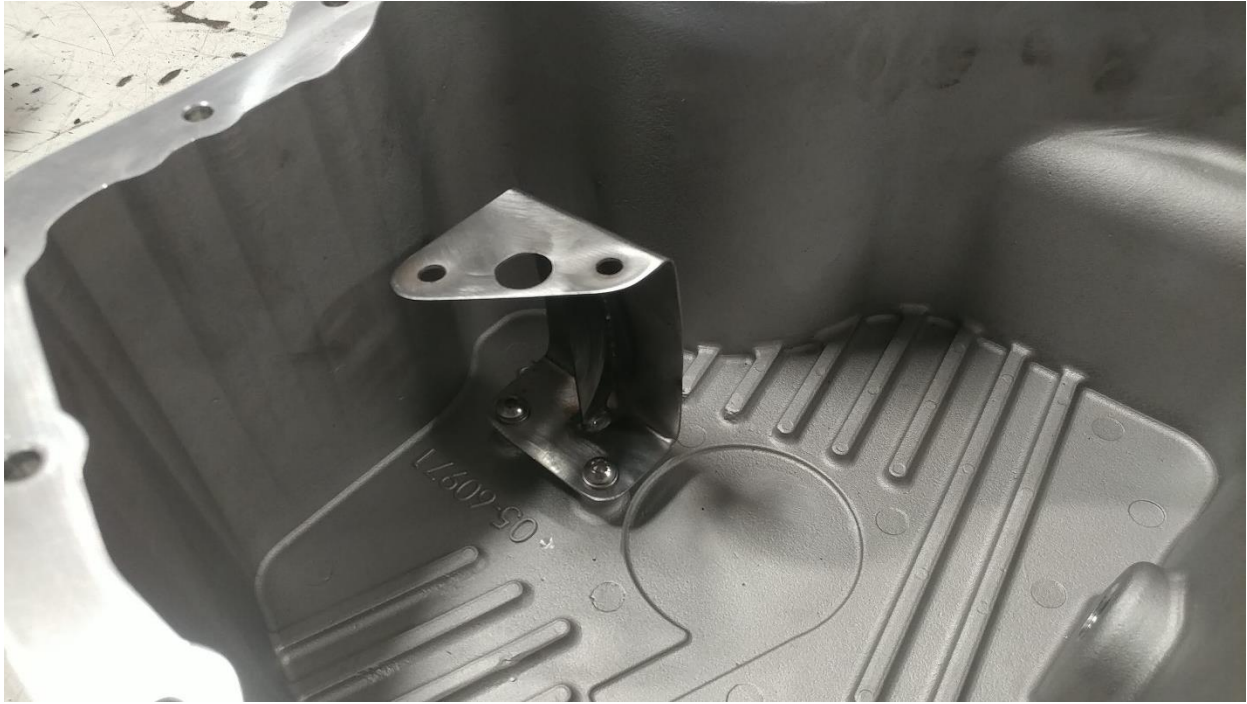

16. Prepare the supplied sensor bracket, oil pan, two (2) M6x1.0x12 button head screws, and two (2) M6 washers. Attach the sensor bracket to the oil pan using the M6x1.0x12 button head screws and M6 washers. Make sure the bracket is facing the correct direction as shown above.



17. Install the sensor to the sensor bracket using the two (2) screws removed in Step 15 and the two (2) M6 nuts used in Step 9.



18. Carefully install the sensor connector in the aFe oil pan by pushing it through from the inside of the pan.
19. Re-install the holding clip on the outside of the pan.



20. Hold the aFe oil pan up to the gasket surface to make sure you will be able to maneuver it into place. We recommend lifting the passenger side of the pan into place first.
21. Once you have a clear path to lift the aFe oil pan into place, prepare all the required hardware to secure it into place. This includes the 17 supplied M6x1.0x20 socket head screws and M6 washers.
22. Spread the supplied RTV silicone across the gasket surface. Be generous when spreading the silicone across the surface and make sure that all the bolt holes are completely surrounded.



23. Hold the oil pan up into position, aligning the screw holes. Install four (4) M6x1.0x20 socket head screws and M6 washers into each of the corners to hold the pan into place.

Note: Be careful not to move the pan around once it touches the gasket surface.

24. Continue installing the 14 remaining M6x1.0x20 socket head screws and M6 washers finger tight.

25. Torque the mounting screws to 8 ft. -lbs. in a crisscross pattern.



Note: If using an oil heater, apply Teflon pipe sealant to it instead of the 1/2" NPT plug.

26. Apply Teflon pipe sealant tape to the threads of the supplied 1/2" NPT plug.



27. Reconnect the sensor connector.

Note: If using an oil heater, install it instead of the 1/2" NPT plug.

28. Install the 1/2" NPT plug into the side of the aFe oil pan.

29. Install the supplied M12x1.25 magnetic drain plug and crush washer into the bottom drain hole.



30. Re-install the transmission bolt removed in Step 11, using the supplied M10 washer.



31. Remove your old oil filter and allow the remaining oil to drain.

32. Install the supplied oil filter. Only hand tighten the filter.

33. Refill the engine with new oil. Your aFe pan holds about 1 quart more than stock, about 11 quarts overall (fill to full line on dipstick).

Note: The truck needs to be warmed up and oil has to have run through the oil filter in order to get an accurate reading on the dipstick.



34. Once you reinstall the cross member, your installation is complete. Verify all connections are secure before driving.

Warranty

General Terms:

- aFe warrants their products to be free from manufacturer’s defects due to workmanship and material.
- This warranty applies only to the original purchaser of the product and is non-transferrable.
- Proof of purchase of the aFe product is required for all warranty claims.
- Warranty is valid provided aFe instructions for installation and/or cleaning were properly followed.
- Proper maintenance with regular inspections of product is required to insure warranty coverage.
- Damage due to improper installation, abuse, unauthorized repair or alteration is not warranted.
- Incidental or consequential damages or cost, including installation and removal of part, incurred due to failure of aFe product is not covered under this warranty.
- All warranty is limited to the repair and/or replacement of the aFe part. To request Return Goods Authorization (“RGA”), email RGA@afepower.com or call (951)493-7100. Upon receipt of the RGA, you must return the product to the address provided in the RGA, freight prepaid and accompanied with a dated proof of purchase and the RGA. Upon receipt of the defective product and upon verification of proof of purchase, aFe will either repair or replace the defective product within a reasonable time, not to exceed thirty days.

Product Category	P/N Prefix	Warranty Duration
Direct OE Replacement Filters	10,11,30,31,71,73	Life of the vehicle
Racing Filters	18	1 year
Universal	21,24,72	2 years
Air Intake Systems	50,51,54,55,75	2 years
Exhaust Systems	49	2 years
Intercoolers & Intercooler Tubes	46-2	2 years
Intake Manifolds	46-1	2 years
Differential Covers/Transmission Pans/ Oil Pans	46-7	Life of the vehicle
Exhaust Manifolds	46	2 years
Throttle Body Spacers	46-3	2 years
Fluid Filters	44	90 days
Pre-Filters	28	2 years
Heavy Duty OE Replacement	70	2 years
PowerSports OE Replacement	81,87	2 years
PowerSports Intake Systems	85	2 years

No other warranty expressed or implied applies nor is any person or advanced FLOW engineering authorized to assume any other warranty. Some States do not allow the exclusion or limitation of incidental or consequential damages or do not allow limitations on how long an implied warranty lasts, so the above limitations or exclusions may not apply to you. This warranty gives you specific legal rights, and you may also have other rights which vary from State to State.

This Page Was Left Intentionally Blank



advanced FLOW engineering, inc.

252 Granite Street Corona, CA 92879

TEL: 951.493.7100 • TECH: 951.493.7100 x23

E-Mail: Tech@aFepower.com

**06-81257
8-13-2019 DMR**