



INSTALLATION INSTRUCTIONS

MAKE: Infiniti
MODEL: Q50
YEAR: 2016-2021 Sport / Red Sport 400
ENGINE: V6-3.0L (tt)

Axle-Back Exhaust

49-36130NM-P (Polished Tips)
49-36130NM-B (Black Tips)
49-36130NM-L (Blue Flame Tips)
49-36130NM-C (Carbon Fiber Tips)

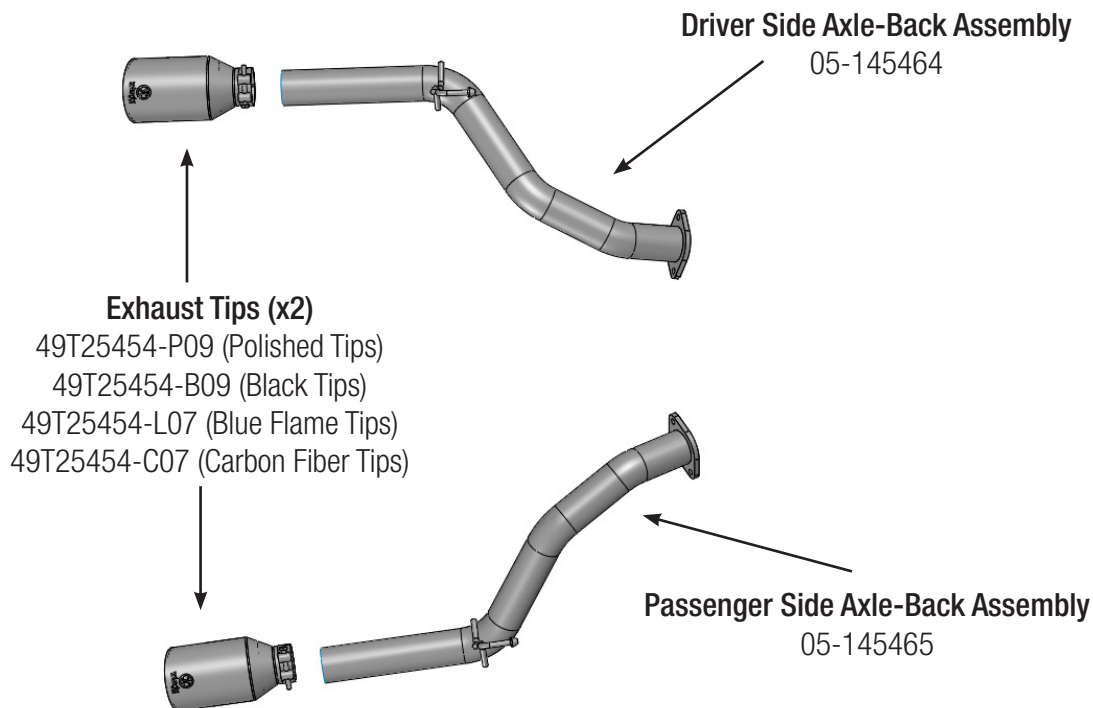

Professional installation is highly recommended. (Read instructions prior to installation). Make sure to always have at least (2) stands or jacks on hand to support the removal of OE system. Also for the installation of aFe system. Any Removal of rubber isolation mounts may require using a spray lubricant such as WD40 and a pry bar.

Step 1. (Read Instructions prior to installation) for faster removal and installation of exhaust a trained professional is recommended for this procedure.

Step 2. Secure stock exhaust with jack/stands.

Step 3. Remove the six bolts securing the rear two rubber isolation mounting brackets to the vehicle chassis.

Step 4. Retain hardware for TAKEDA exhaust installation. Remove the stock muffler.

Step 5. Transfer the OE rubber isolation mounting brackets to the TAKEDA axle back one at a time. Ensure that the brackets are positioned in the same orientation that they were on the stock system.

Step 6. Install the TAKEDA axle back driver side using the stock hardware.

Step 7. Install the TAKEDA axle back passenger side using the stock hardware.

Step 8. Install the exhaust tips onto the muffler section and snug them down, **but do not fully tighten.**

Step 9. Align the exhaust tips in the outlets.

Step 10. Once aligned and you're satisfied, you may now tighten complete system.

Step 11. Start the vehicle and check for any leaks.

Step 12. Remove the vehicle from the jack/stands.

Step 13. Double check all work and ensure everything is tight Congratulations, your system is now complete and full.

Step 14. Installed! It is recommended to re-tighten all clamps and bolts after 50-100 miles.

Caution: Allow time for your vehicle to cool down prior to installation. When working on or under your vehicle proceed with caution. Exhaust systems reach high temperatures and may cause serious burns. Wear protective safety equipment; eye goggles and gloves to ensure a safe installation. **aFe recommends professional installation on our products.**