



INSTALLATION INSTRUCTIONS

Cat-Back Exhaust

MAKE: Ford
 MODEL: F-250/350 SD
 YEAR: 17-21
 ENGINE: V8-7.3L/6.2L

49-43117-P
 49-43117-B

NOTE: Will Only Fit 160" Wheelbase

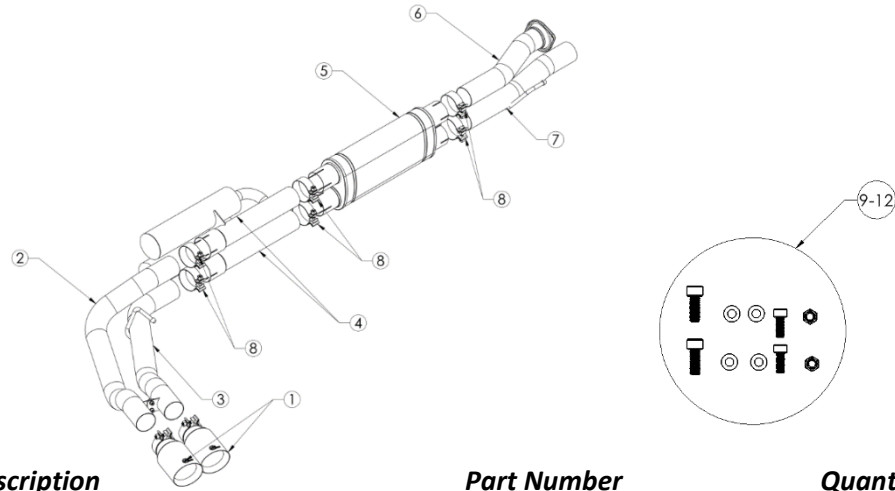

Item	Description	Part Number	Quantity
1	EXH Tip 3 In x 4-1/2 Out x 9L Bolt-On Pol	49T30454-P092	2
1	EXH Tip 3 In x 4-1/2 Out x 9L Bolt-On Blk	49T30454-B092	2
2	S/A Tail Pipe Driver Side	05-144950	1
3	S/A Tail Pipe Passenger Side	05-144951	1
4	S/A Helmholtz Tubes	05-144983	2
5	Muffler, 409SS: Dual 3" In/Out, 5" x 8" Body	R49-91015	1
6	S/A Front Pipe DS	05-144948	1
7	S/A Front Pipe PS	05-144949	1
8	Clamp, Band: 3"	05-41055	6
9	Screw, Socket head Cap: M8 x 1.25 x 20	03-50341	2
10	Washer, Flat M8: 16mm OD	03-50159	4
11	Nut, Hex Oval Lock: M8 x 1.25	05-46057	2
12	Screw Socket head Cap, M10 x 1.5 x 25mm	03-50418	2

aFe POWER recommends professional installation on this product. Thoroughly inspect the aFe POWER exhaust system to make sure there is no damage from shipping (if damage is noted, immediately contact aFe POWER customer service). Allow time for your vehicle to cool down prior to installation. When working on your vehicle proceed with caution. Wear protective safety equipment; eye goggles and gloves to ensure a safe installation.

Install band clamps to proper torque specifications of 40-45 ft-lb.





INSTALLATION INSTRUCTIONS

MAKE: Ford
MODEL: F-250/350 SD
YEAR: 17-21
ENGINE: V8-7.3L/6.2L

Cat-Back Exhaust

49-43117-P

49-43117-B

NOTE: Will Only Fit 160" Wheelbase

1. **(Read instructions prior to installation.)** It is recommended to not fully tighten the exhaust until it has been fully installed. Leave loose for adjustability.
2. Secure vehicle on jack stands (refer to your manual for specified jack stand positions).
3. For faster installation, spread out the parts of the exhaust alongside your vehicle as shown in the diagram above.
4. Secure the stock exhaust with jack/stands.
5. Remove the O.E. axle back section up to the first clamp joint.
6. Remove the rest of the cat back section up to the flanged joint and slip joint at the back of the O.E Y-Pipe.
7. Install both front pipes, one pipe will re-use the O.E. slip clamp and the other pipe will use the(x2) provided bolts 03-50418. Slide the hanger into the O.E. isolation mount
8. Install the muffler using the provided 3" band clamps.
9. Install Both Helmholtz chambers using the provided 3" band clamps. Rotate the Helmholtz chambers so they have clearance from the frame or the driveline of the vehicle.
10. Install both tailpipes using the provided 3" band clamps. Slide the hanger into the O.E. isolation mount. Then using the provided (x2) nuts and bolts, bolt the two tailpipes together.
11. Install the tips using the provided band clamps.
12. Adjust the tips to desired position and tighten.
13. Ensure that all the components of the aFe POWER exhaust system are aligned and are at a safe clearance from all wires, hoses, brake lines, body parts, and tires.
14. Start from the front of the aFe exhaust system and evenly tighten all clamps and fasteners.
15. Start the vehicle and check for any leaks. If any leaks are found, determine cause and repair as necessary.
16. Remove vehicle from jacks stands.
17. It is recommended to re-tighten all clamps and hardware after 50-100 miles.