

advanced FLOW engineering Magnum FORCE Stage-2 Cold Air Intake System

Instruction Manual P/N: 54-13047D / 54-13047R

Make: RAM

Model: 2500/3500

Year: 2019-2020

Engine: V8-6.4L HEMI



- Please read the entire instruction manual before proceeding.
- Ensure all components listed are present.
- For technical support please call 951-493-7185.
- Ensure you have all necessary tools before proceeding.
- Do not attempt to work on your vehicle when the engine is hot.
- Retain factory parts for future use.

Label	Qty.	Description	Part Number
A1	1	Air Filter (Pro DRY S)	21-91120
A2	1	Air Filter (Pro 5R)	24-91120
B	1	Housing	05-5413016B2
C	1	Tube	05-5413047B1
D	1	Coupling, Silicone Reducer: (3-3/4" x 3-1/2")ID x 3"L	05-01508
E	38	Seal, Trim	05-01534
F	24	Silicone Hose, 5/8" ID (26"L)	05-01502
G	1	Clamp, #060	03-50002
H	1	Clamp, #056	03-50009
I	1	Fitting, 5/8" Coupling	03-50183
J	1	Grommet	03-50167
K	1	Fitting, Air Temperature Sensor	05-01454

Installation will require the following tools:

8mm & 10mm nut driver

Emissions Disclaimer: This product is not currently CARB exempt and is not available for purchase in California or for use on any vehicle registered with the California Department of Motor Vehicles.

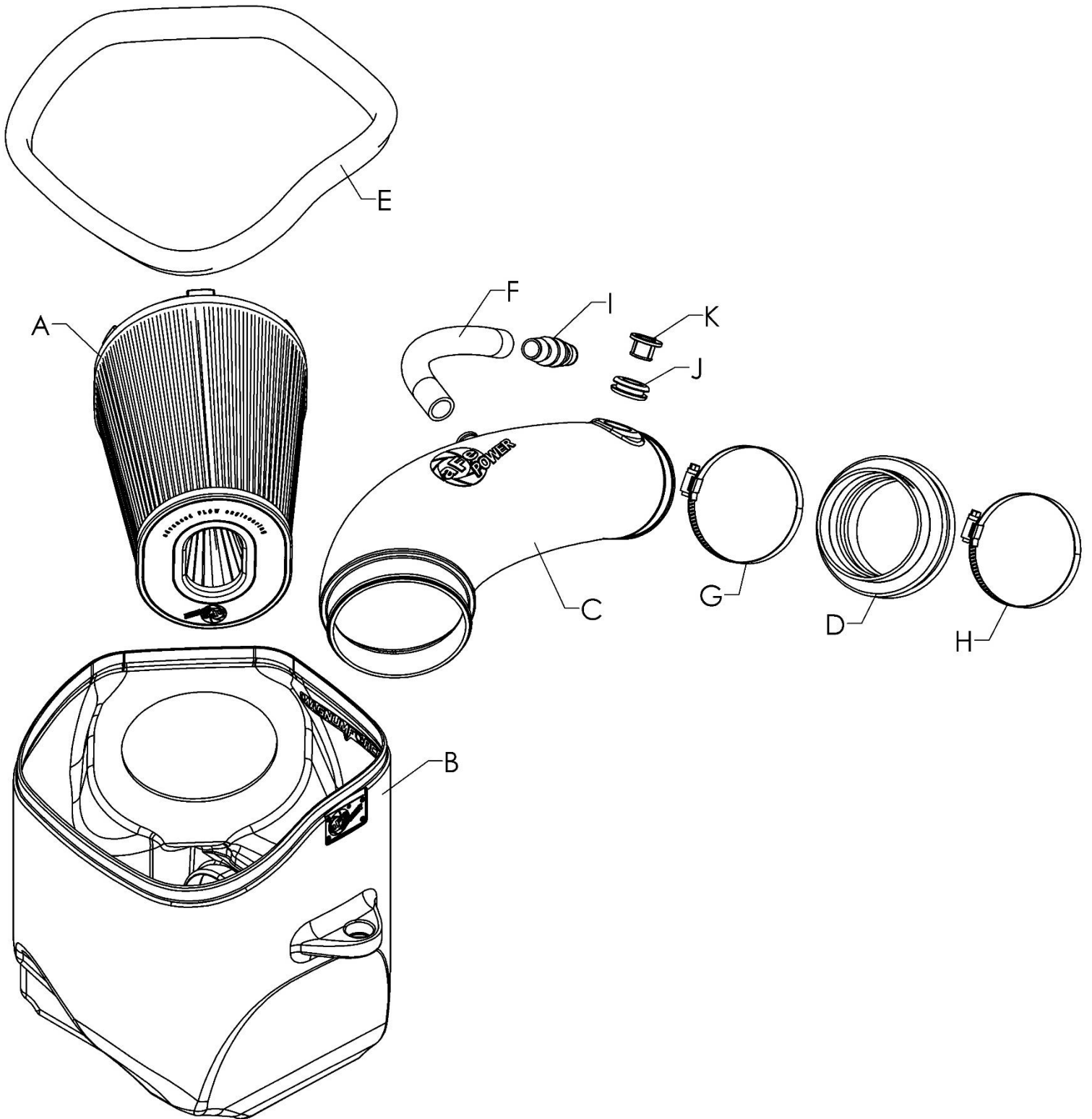

**Figure A****Refer to Figure A for Step 1**

Step 1: Remove the engine cover ① by pulling straight up on the front edge until it disengages, then pulling straight forward.

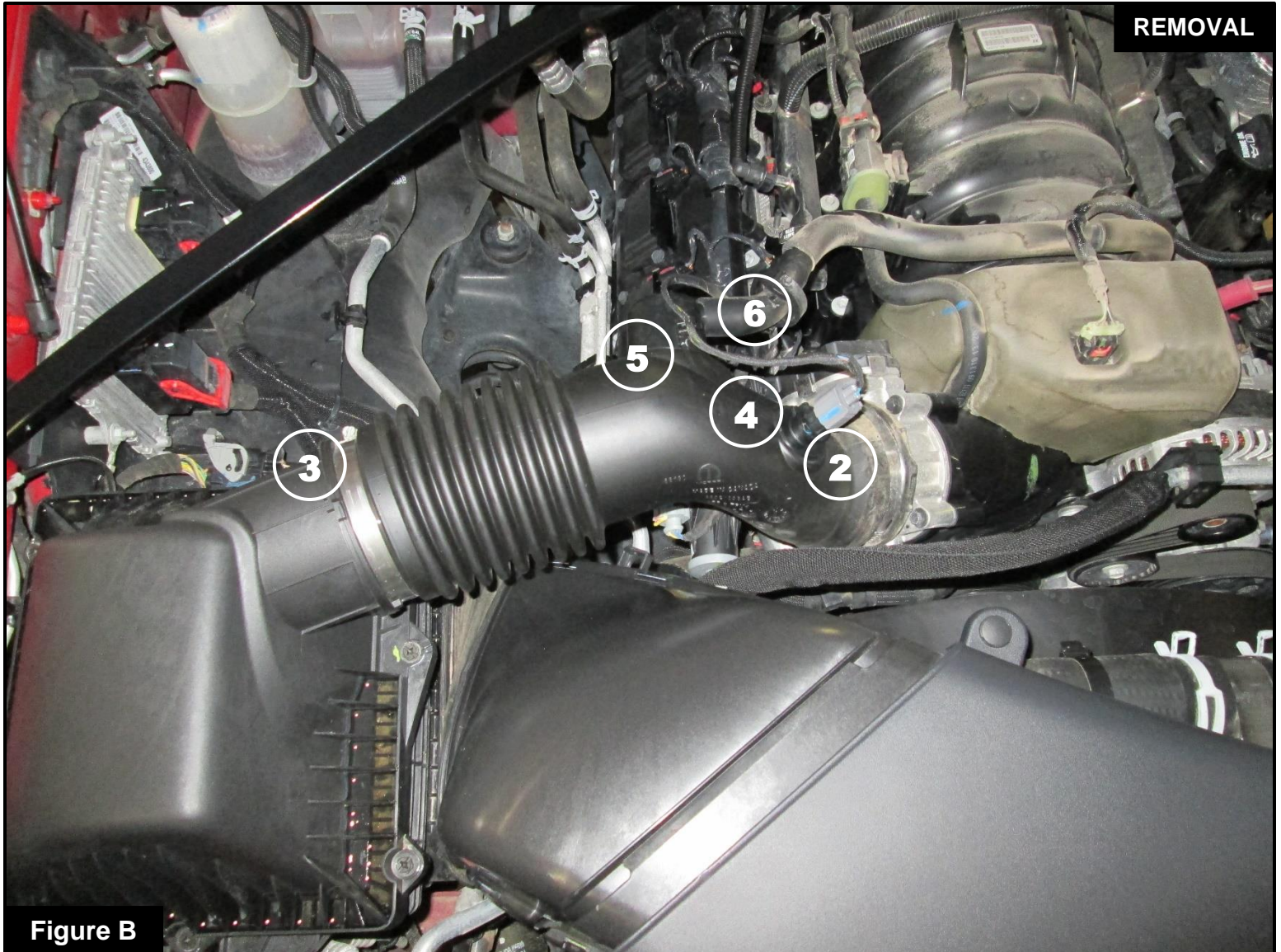

Refer to Figure B for Steps 2-5

Step 2: Using an 8mm nut driver, loosen the clamps at the throttle body (2) and filter housing (3).

Step 3: Disconnect the temperature sensor (4) and unclip the wire from the intake tube (5).

Step 4: Disconnect the CCV hose (6) from the intake tube.

Step 5: Remove the intake tube from the vehicle.

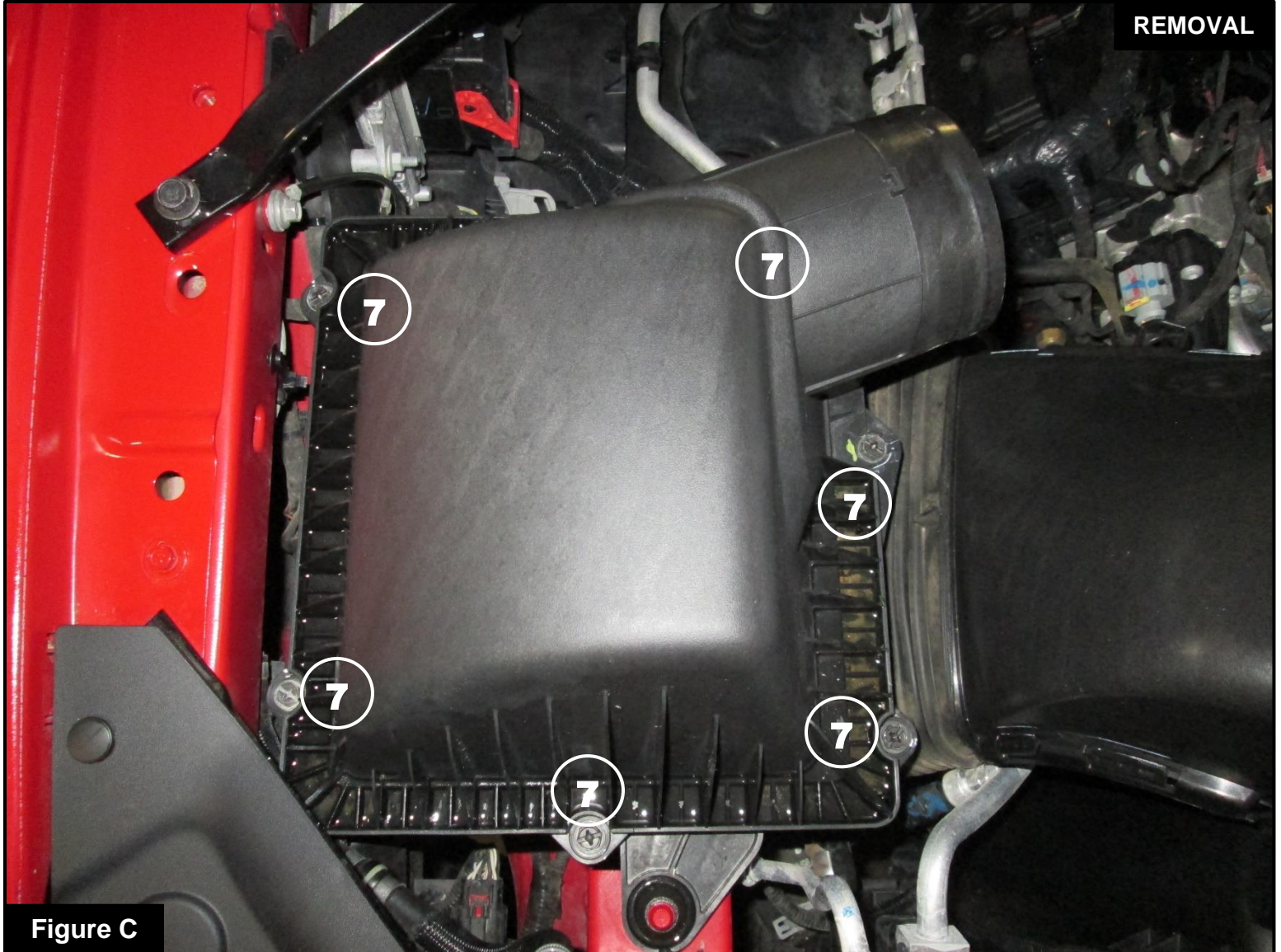
**Figure C****Refer to Figure C for Step 6**

Step 6: Using a 10mm nut driver, loosen the 6x screws (7) holding the top half of the stock filter housing, then remove the lid.

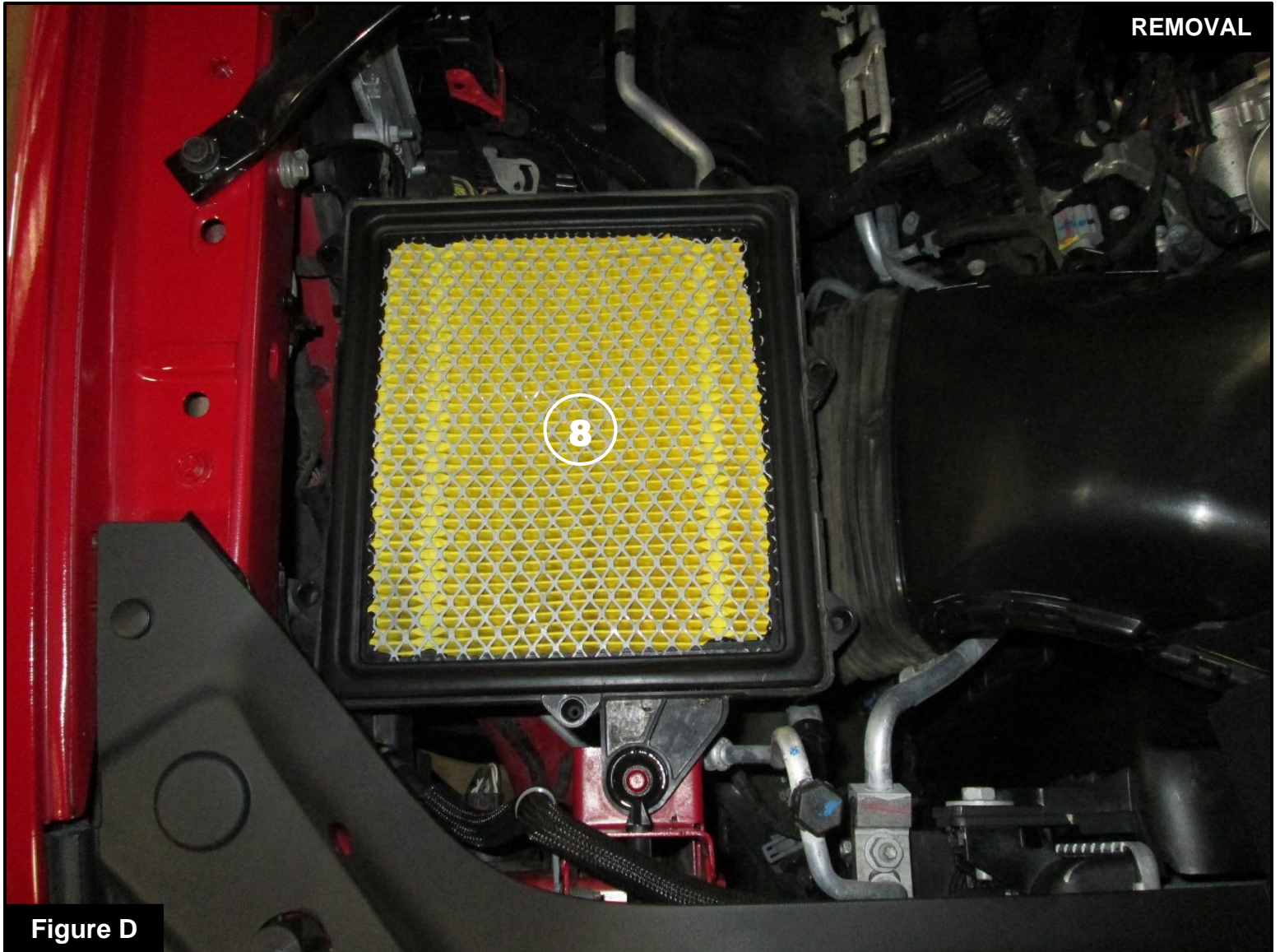

Figure D

Refer to Figure D for Step 7

Step 7: Remove the factory air filter (8) and set aside.



Figure E

Refer to Figure E for Steps 8-9

Step 8: Remove the stock inlet duct (9) from the vehicle by pressing out from the bottom of the stock housing, then disconnecting from the inlet scoop.

Step 9: Keeping the stock inlet duct in the vehicle, pull straight up on the bottom of the stock filter housing to disengage from the mounting grommets, and remove it from the vehicle.

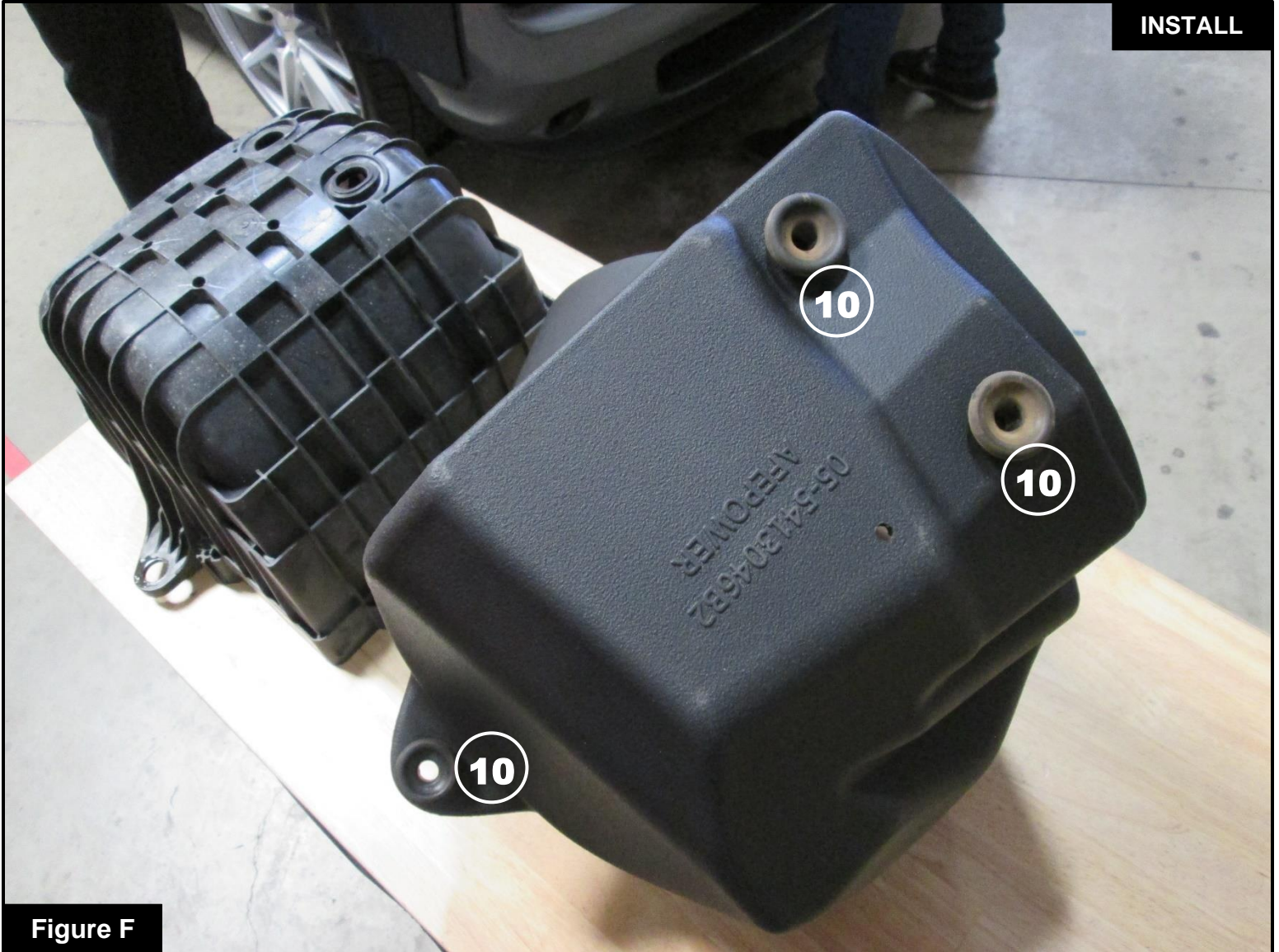

Figure F

Refer to Figure F for Step 10

Step 10: Transfer the 3x stock grommets (10) from the stock housing to your aFe Power housing.



Figure G

Refer to Figure G for Step 11

Step 11: Install your aFe Power housing into the vehicle by lowering it into the vehicle, inserting the stock inlet scoop, then pressing firmly to secure it on all 3 mounting grommets.

**Figure H****Refer to Figure H for Step 12**

Step 12: Install the supplied seal trim (11) along the open edge of your aFe Power housing. Trim to fit.



Figure I

Refer to Figure I for Step 13

Step 13: Remove the stock CCV line (12) from the vehicle.

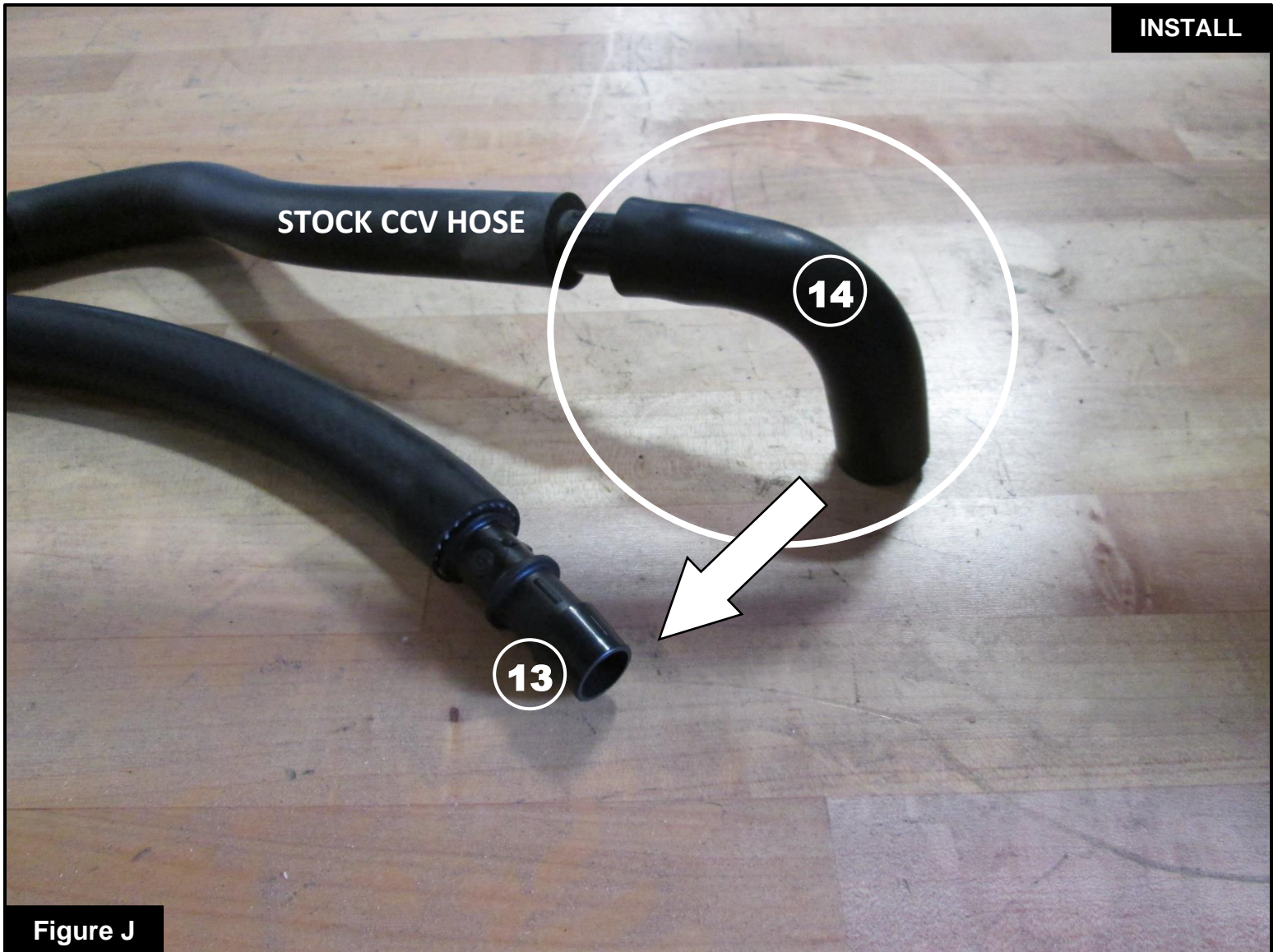
**Figure J****Refer to Figure J for Steps 14-15**

Step 14: Install the supplied fitting (13) into one end of the supplied silicone hose as shown above.

Step 15: Disconnect and transfer the elbow piece (14) of the stock CCV hose to the other end of the fitting in your new silicone hose assembly.



Refer to Figure K for Steps 16-17

Step 16: Install the supplied fitting rubber grommet and fitting (15) into your aFe Power intake tube as shown. A small amount of silicone grease may be used to ease the install of the fitting into the grommet.

Step 17: Transfer the temperature sensor (16) from the stock intake tube into the fitting on your aFe Power intake tube.

**Figure L****Refer to Figure L for Step 18**

Step 18: Remove the filter clamp ⑰ from your aFe Power air filter. Slide the filter into your housing from the top, then guide the filter flange through the round opening, pressing gently until the base of the filter snaps into place. Place the filter clamp back on the filter flange.

**Figure M****Refer to Figure M for Steps 19-21**

Step 19: Install the supplied bellows coupler (18) with the smaller end on the throttle body.

Step 20: Install the smaller supplied #56 clamp (19) on the throttle body side of the coupler. Tighten using an 8mm nut driver.

Step 21: Place the larger supplied #60 clamp (20) loosely on the open end of the coupler. Do not tighten at this time.



Refer to Figure N for Step 22

Step 22: Install your aFe Power intake tube into the vehicle by sliding the smaller end into the coupler at the throttle body, then rotating the large end into the air filter. Tighten all clamps using an 8mm nut driver.

**Figure O****Refer to Figure O for Steps 23-24**

Step 23: Install your modified CCV line (21) with the elbow on the crankcase port. Route the silicone hose underneath the smaller vacuum line (22) and attach the open end to the port on your intake tube as shown above.

Step 24: Reconnect the temperature sensor wire harness (23).



Refer to Figure P for Steps 25-26

Step 25: Reinstall your engine cover.

Step 26: Check that all components are tight and secure. Your installation is now complete. Thank you for choosing aFe POWER!

NOTE: Check all screws, clamps, and connectors are secure after 100-200 mi



PAGE LEFT BLANK INTENTIONALLY



PAGE LEFT BLANK INTENTIONALLY



Pro DRY S Air Filter



P/N: 21-91120

Pro 5R Air Filter



P/N: 24-91120

Pro GUARD 7 Air Filter



P/N: 72-91120

Magnum SHIELD Pre-Filter



P/N: 28-10033

Pro DRY S Restore Kit



P/N: 90-59999

Pro 10R / Pro 5R Restore Kit



P/N: 90-50501

Pro GUARD 7 Restore Kit



P/N: 90-50500

Silver Bullet Throttle Body Spacer



P/N: 46-32007

Sprint Booster V3



P/N: 77-12007

aFe POWER Backpack



P/N: 40-33205-B

aFe POWER LED Flashlight



P/N: 40-10202

aFe POWER Battery Pack

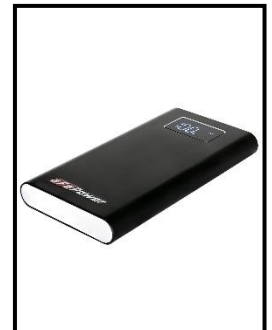

P/N: 40-10198

To purchase any of the items above, view airflow charts, dyno graphs, photos, and video; please go to aFepower.com



Warranty

General Terms:

- aFe warrants their products to be free from manufacturer's defects due to workmanship and material.
- This warranty applies only to the original purchaser of the product and is non-transferrable.
- Proof of purchase of the aFe product is required for all warranty claims.
- Warranty is valid provided aFe instructions for installation and/or cleaning were properly followed.
- Proper maintenance with regular inspections of product is required to insure warranty coverage.
- Damage due to improper installation, abuse, unauthorized repair or alteration is not warranted.
- Incidental or consequential damages or cost, including installation and removal of part, incurred due to failure of aFe product is not covered under this warranty.
- All warranty is limited to the repair and/or replacement of the aFe part. To request Return Goods Authorization ("RGA"), email RGA@afepower.com or call (951)493-7100. Upon receipt of the RGA, you must return the product to the address provided in the RGA, freight prepaid and accompanied with a dated proof of purchase and the RGA. Upon receipt of the defective product and upon verification of proof of purchase, aFe will either repair or replace the defective product within a reasonable time, not to exceed thirty days.

Product Category	P/N Prefix	Warranty duration
Direct OE Replacement Filters	10, 11, 30, 31, 71, 73	Life of the vehicle
Racing Filters	18	1 year
Universal	20, 21, 23, 24, 72, TF	2 years
Air Intake Systems	50, 51, 53, 54, 55, 56, 57, 58, 75, TR, TA, TL, TM	2 years
Exhaust Systems	49	2 years
Intercoolers & Intercooler Tubes	46-2	2 years
Intake Manifolds	46-1	2 years
Differential Cover	46-7	Life of the vehicle
Exhaust Manifolds	46	2 years
Throttle Body Spacers	46-3	2 years
Turbochargers	46-6	2 years*
Fluid Filters	44	90 days
Pre-Filters	28	2 years
Heavy Duty OE Replacement	70	2 years
PowerSports OE Replacement	81, 87	2 years
PowerSports Intake Systems	85	2 years

No other warranty expressed or implied applies nor is any person or advanced FLOW engineering authorized to assume any other warranty. Some States do not allow the exclusion or limitation of incidental or consequential damages or do not allow limitations on how long an implied warranty lasts, so the above limitations or exclusions may not apply to you. This warranty gives you specific legal rights, and you may also have other rights which vary from State to State.

*See turbocharger warranty for more info



advanced FLOW engineering, inc.

252 Granite Street Corona, CA 92879

TECH: 951.493.7185

E-Mail: Tech@aFepower.com

P/N: 06-81362